

# TiLite Options

Your style, your  
performance



permobil

## Front wheels

- 1 **FW24** 3"x1.5" LiteSpeed Billet Aluminum Wheel w/Soft Roll Tire
  - Silver Hub OR Black Hub
- 2 **FW14** 4"x.75" Plastic Wheel w/Poly Tire
- 3 **FW3** 4"x.75" Light-Up Micro-Caster
- 4 **FW27** 4"x1.5" LiteSpeed Billet Aluminum Wheel w/Soft Roll Tire
  - Silver Hub OR Black Hub
- 5 **FW6** 5"x1" Plastic Wheel w/Poly Tire
- 6 **FW30** 5"x1.5" LiteSpeed Billet Aluminum Wheel w/Soft Roll Tire
  - Silver Hub OR Black Hub
- 7 **FW28** 5"x1.5" LiteSpeed Plastic Wheel w/Soft Roll Tire
- 8 **FW33** 6"x1.5" LiteSpeed Billet Aluminum Wheel w/Soft Roll Tire
  - Silver Hub OR Black Hub

### Options not shown

- FW26** 4"x1.5" LiteSpeed Plastic Wheel w/Soft Roll Tire
- FW9** 6"x1" Plastic Wheel w/Poly Tire
- FW32** 6"x1.5" LiteSpeed Plastic Wheel w/Soft Roll Tire



## Front forks

- 1 **GL1** Glide™ Suspension Fork
- 2 **FK1** TiLite Standard Fork
- 3 **FK2** TiLite Slipstream Single-Sided Fork



## Axles

- 1 **AXL1** Stainless Quick Release
- 2 **AXL3** Quad Release

### Options not shown

- AXL2** Titanium Quick Release





## Rear wheels

### Rear wheels by Out-Front®

- 1 RW14 SHADOW

### Performance rear wheels

- 2 RW16 Spinergy Carbon Blade
- 3 RW8 Spinergy LX
- 4 RW7 Spinergy SPOX
- 5 RW17 X-Core Mag



Available in 20"(451), 22"(501), 24"(540), 25"(559) and 26"(590) sizes.



Available in 24"(540) and 25"(559) sizes.



Available in 22"(501), 24"(540), 25"(559) and 26"(590) sizes.

Available spoke colors



\*Purple only available in size 22"



Available in 22"(501), 24"(540), 25"(559) and 26"(590) sizes.

Available spoke colors



Available in 20"(451), 22"(501) and 24"(540) sizes.

Available colors



\*Red, pink and white are only available on the TiLite Pilot



## Rear tires

### Pneumatic rear tires

- 1 **RTR1** Treaded 22"(501), 24"(540) & 26"(590)
- 2 **RTR3** Primo Treaded 25"(559)
- 3 **RTR4** Primo 20"(451), 22"(501), 24"(540), 25"(559) & 26"(590)
- 4 **RTR8** Schwalbe® Marathon Plus Evolution 24"(540), 25"(559) & 26"(590)
- 5 **RTR30** Primo Sentinel 20"(451), 22"(501) & 24"(540)
- 6 **RTR9** Schwalbe® Slick 24"(540) & 25"(559)
- 7 **RTR24** Kenda Kobra 24"(540)

### Solid rear tires

- 8 **RTR22** Primo Express 20"(451), 22"(501), 24"(540) & 25"(559)
- 9 **RTR23** Primo Active 24"(540) & 25"(559)



# Handrims

## Standard handrims

- 1 **RIM1** Aluminum – Silver Anodized
- 2 **RIM21** Aluminum – Black Anodized
- 3 **RIM12** Titanium – Satin Finish

## Handrims by Out-Front®

- 4 **RIM14** The Natural-Fit® Standard Grip  
*Original, Larger Profile*
- 5 **RIM18** The Natural-Fit® LT Super Grip  
*Reduced Weight, Smaller Profile*
- 6 **RIM10** The Surge  
*All-In-One Oval with Gription™ Strip, Larger Profile*
- 7 **RIM11** The Surge LT  
*All-In-One Oval with Gription™ Strip, Smaller Profile*
- 8 **RIM20** Q-Grip  
*Exclusive High-Friction, Anti-Slip Coating*

## Options not shown

- RIM15** The Natural-Fit  
*With Super Grip Original, Larger Profile*
- RIM16** The Natural-Fit  
*Without Thumb Grip Original, Larger Profile*
- RIM17** The Natural-Fit LT Standard Grip  
*Reduced Weight, Smaller Profile*
- RIM19** The Natural-Fit LT  
*Without Thumb Grip Reduced Weight, Smaller Profile*
- RIM5** Plastic Coated – Black



## Back Upholstery

- 1 **BUP2** Velcro Adjustable
- 2 **BUP3** Tension Adjustable by Straps
- 3 **BUP5** AIR Breathable Upholstery
- 4 **UPC3** Ultrasuede Backrest Stripe

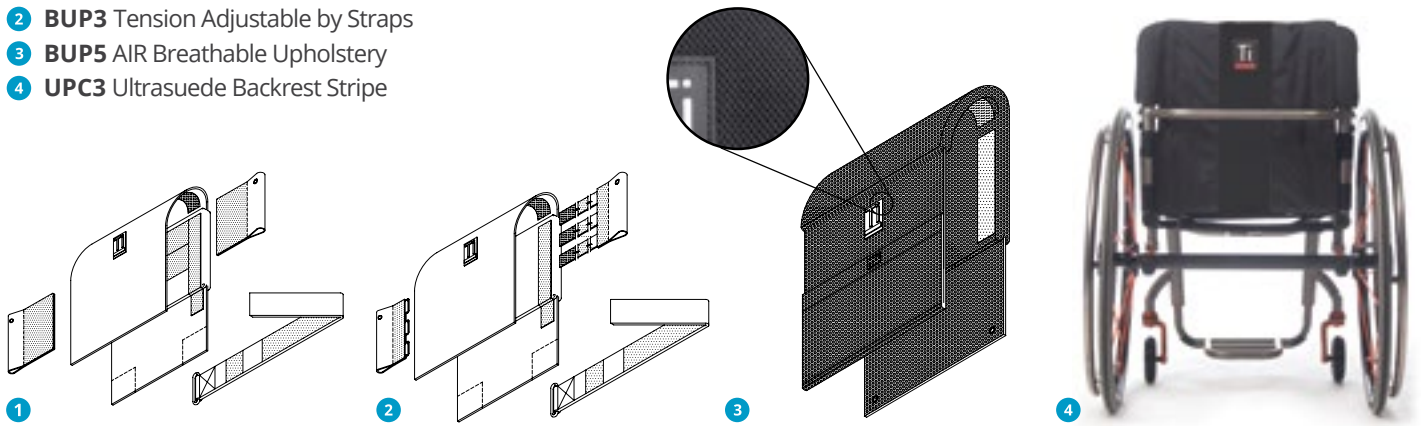

## Seat Upholstery

- 1 **SUP1** Tension Adjustable Bolt On
- 2 **SUP2** Tension Adjustable by Straps
- 3 **SUP8** Aluminum Solid Seat
- 4 **SUP4** Tension Adjustable for Folding Chairs

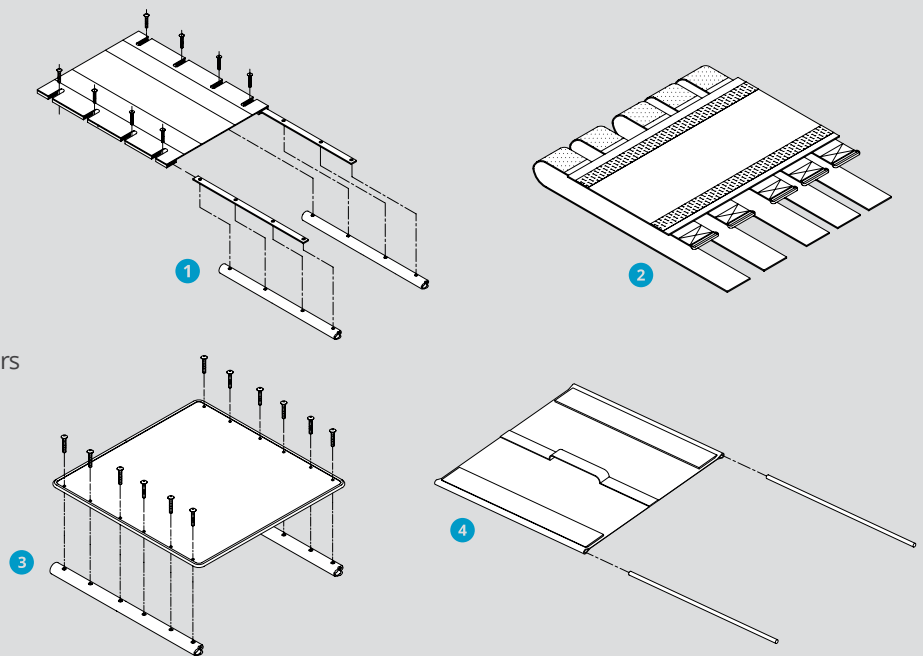

## Wheel locks

### Composite wheel locks by Out-Front®

- 1 **WLK7** Push OR **WLK8** Pull (shown)
- 2 **WLK9** Scissor
- 3 **WLK10** Extension Handles for Push OR Pull

### Additional wheel locks

- 4 **WLK3** Uni-Lock All-in-One Push OR Pull

### Options not shown

- WLK4** Extension Handles for Uni-Lock
- WLK15** Grade Aids Push to Lock

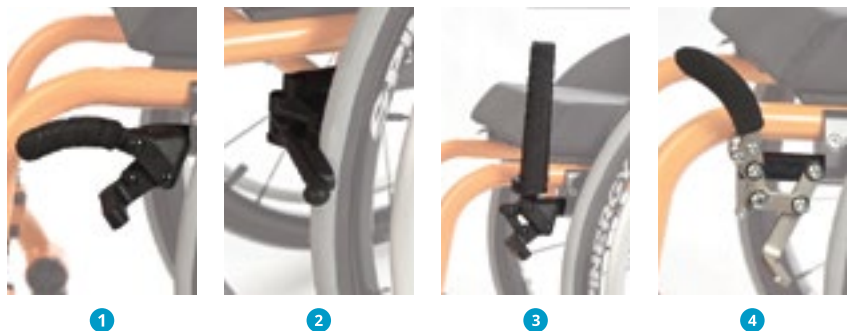



## Side guards

- 1 **SDG7** Carbon Fiber Rigid Removable
- 2 **SDG8** Carbon Fiber Quad Removable w/Hole
- 3 **SDG9** Carbon Fiber Fold Down Rigid
- 4 **SDG12** Carbon Fiber Fendered Removable
- 5 **SDG6** Aluminum Fendered Adjustable

### Options not shown

- SDG2** Aluminum Rigid Removable
- SDG3** Aluminum Quad Removable w/ Hole
- SDG4** Aluminum Fold Down Rigid
- SDG11** Carbon Fiber Fendered Adjustable

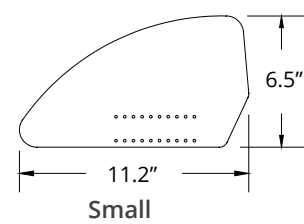
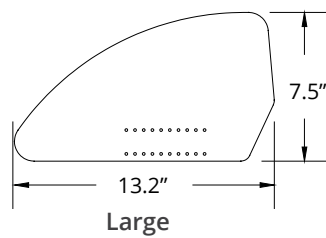



## Armrests

- 1 **ARM1** Swing Away Tubular
- 2 **ARM4** Swing Away - Flip Back Tubular
- 3 **ARM2** Removable Height Adjustable Desk Arm with Rigid Side Guard
- 4 **ARM3** Removable Height Adjustable Desk Arm with Rigid Side Guard and Transfer Loop

### Options not shown

**ARM5** Covered in Black Ultrasuede





## Footrests

### Rigid chair footrests

- 1 **FTR3** Angle Adjustable Footrest
- 2 **FTR1** Titanium Footrest w/Flat ABS Cover
- 3 **FTR2** Titanium Open Loop Footrest
- 4 **FTR12** Titanium Flip-Back Footrest
- 5 **FTR27** Flip-Back Depth & Angle Adjustable High Mount Footrest

### Folding chair footrests

- 6 **FTR5** Flip-up Footrest
- 7 **FTR6** 1-Piece Flip-up Footrest

### Options not shown

**FTR7** 1-Piece, Over-Center Folding Footrest

**FTR9** Depth Adjustable Flip-Up

**FTR11** Angle Adjustable Flip-Up

**FTR10** Depth and Angle Adjustable Flip-Up

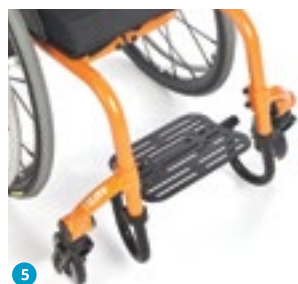
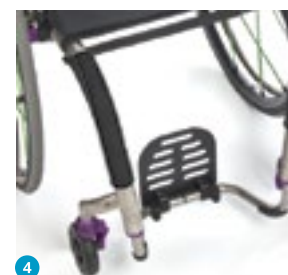
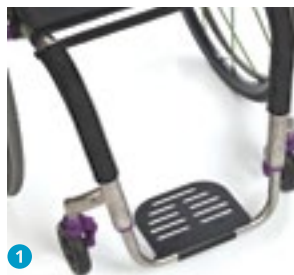

NOTE: For a complete list of Footrest options see TiLite's order forms.

## Anti-tips

- 1 **TIP2** User Friendly Rear Flip-up
- 2 **TIP5** Center Mount Swivel Caster

### Options not shown

**TIP1** Rear Aluminum - Black

**TIP4** Tip Assist

**TIP6** Center Mount Non-Swivel Caster

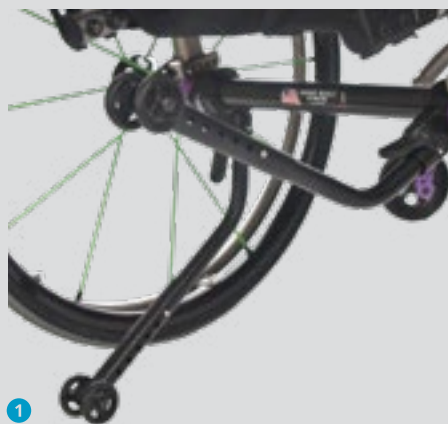

## Push handles

- 1 **SB6** Integrated Push Handles
- 2 **SB7** Integrated Fold-Down Push Handles
- 3 **SB8** Bolt-On Push Handles
- 4 **SB20** Bolt-On Center Mount Height-Adjustable Push Handle

### Options not shown

- SB9** Bolt-On Height-Adjustable Push Handles
- SB21** TWIST Stroller Handle

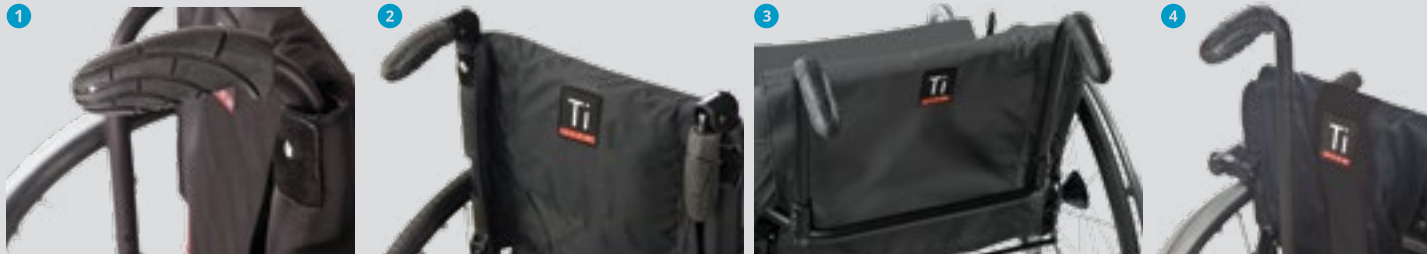

## Additional options

- 1 **SB5** Carbon Fiber TiShaft™ Back Release Bar - Also available in **SB3** Aluminum
- 2 **MPCT2** Neoprene Impact Guards with Ultrasuede Stripe
- 3 **PCH3** Permobil Medical Necessities Seat Pouch, **BCK3** Permobil Medical Necessities Backpack & **PCH4** Bodypoint® Mobility Bag
- 4 **XAFP1** 4" Military Logo Patches
- 5 **LUG1** Luggage Carriers
- 6 **CBR11** Zero Play Aluminum Camber Plugs, **CBR12** Adjustable Rear Wheel Spacing Camber Plugs
- 7 **SB2** & **SB15** Rounded Titanium Rigidizer Bar - Available on rigid chairs (not available on the TWIST)

### Options not shown

**XRSL1** Residual limb support



**NOTE:** Not all options are available on all models. See order forms for availability and pricing. Prices, standard features, options and accessories are subject to change without notice.



## Tattoo options

- 1 Mosaic
- 2 Flower garden
- 3 Need for speed



1



2



3

## Frame colors

### High gloss paint

TiLite red	Neon pink	Super wet black

### Metallic paint

Tangerine metallic	Acid green Metallic	Ocean blue metallic

### Pearlescent paint

Midnight blue pearl	White pearl

### Matte paint

Titanium grey	Black lava

### Candy paint

Ruby red	Azure blue	Electric plum

### Matte textured paint

Flame orange	OD green	Hyper blue

### Natural Titanium

Satin	Polished

## Component colors

### Anodized

Red Pepper	Burnt orange	Sapphire	Ultraviolet	Fuchsia	Black

# Optimize your ride

Permobil designs and builds the best frames out of the best materials, and offers TiFit® in order to ensure that your chair is made to measure to your specific characteristics. But we don't stop there, we also offer you more options to further optimize your ride.

For latest news and updates visit [permobil.com](http://permobil.com)



© 2017 TiLite, LLC. All rights reserved. Trademarks are identified by symbols ™ and ®. TiLite, the TiLite logo, Ti, TiFit, and The Titanium Experts are registered trademarks of TiLite, LLC. Adobe®, Acrobat®, Acrobat Professional® and Reader® are registered trademarks of Adobe Systems Inc. Bodypoint® is a registered trademark of Bodypoint Inc. Kenda® is a registered trademark of Kenda Rubber Industrial Co Ltd. Ride Designs® and Corbac® are registered trademark of Aspen Seating, LLC. ROHO®, Low Profile® and Quadro Select® are registered trademarks of ROHO Inc. Schwalbe® is a registered trademark of Ralf Bohle GmbH. Supracor®, Stimulite® and Corbee® are registered trademarks of Supracor, Inc. The Natural-Fit® is a registered trademark of Three Rivers Holdings, LLC. Varilite® is a registered trademark of Cascade Designs, Inc.